

---

# Dishwasher

*Instruction Manual*

GED45S  
45cm Dishwasher

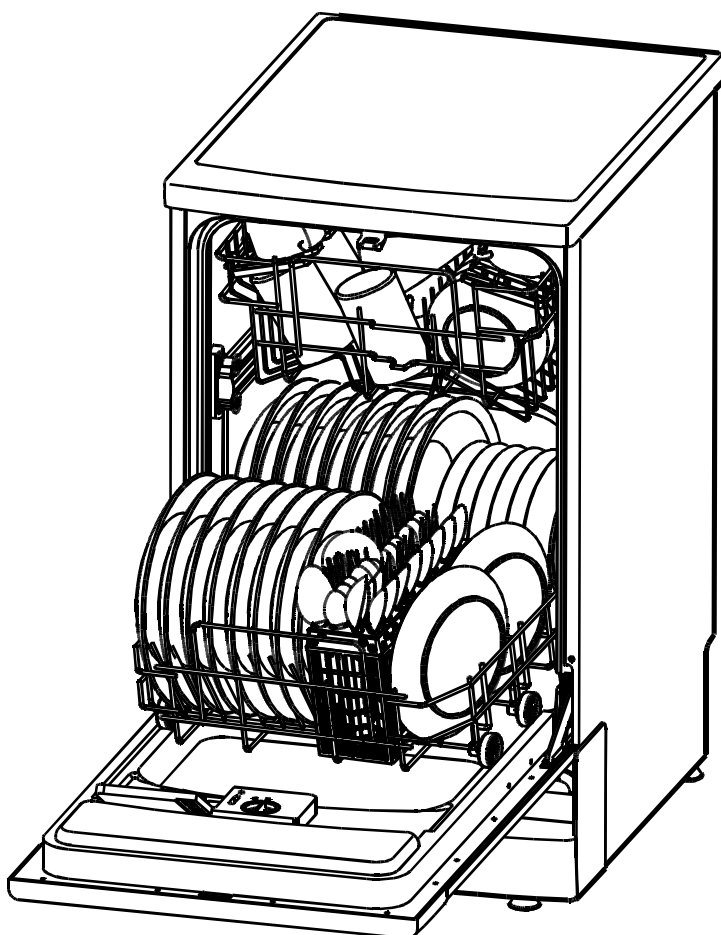



## Read this Manual

Dear Customer,

- Please carefully read this manual before using the dishwasher, it will help you to use and maintain the dishwasher properly.
- Keep it to refer to it at a later date.
- Pass it on to any subsequent owner of the appliance.

This manual contains sections on safety Instructions, Operating Instructions, Installation Instructions and Troubleshooting Tips, etc.



## Before Calling for Service

- To review the section on troubleshooting Tips will help you to solve some common problems by yourself .
- If you can not solve the problems by yourself , please ask for the help of professional technicians.



## NOTE:

The manufacturer, following a policy of constant development and updating of the product, may make modifications without giving prior notice.

<b>1) Safety Information.....</b>	<b>1</b>
<b>2) Operating Instructions.....</b>	<b>2</b>
Control Panel.....	2
Dishwasher Features.....	2
<b>3) Prior using for the first time.....</b>	<b>3</b>
A、 Fill the Rinse Aid Dispenser.....	3
B、 Function of Detergent .....	5
How to use the 3in1 Function.....	7
<b>4) Loading the Dishwasher Basket.....</b>	<b>8</b>
Attention before or after loading the Dishwasher Baskets.....	8
Loading the upper Basket.....	8
Loading the Lower Basket.....	9
Cutlery Basket.....	10
<b>5) Starting a washing programme.....</b>	<b>12</b>
Wash Cycle Table.....	12
Turning on the Appliance.....	13
Change the Programme.....	13
At the End of the Wash Cycle.....	13
<b>6) Maintenance and cleaning.....</b>	<b>14</b>
Filtering System.....	14
Caring for the Dishwasher.....	15
<b>7) Installation instruction.....</b>	<b>16</b>
About Electricity Connecting.....	16
Water Connection.....	17
Positioning the Appliance.....	18
Start of Dishwasher .....	18
<b>8) Troubleshooting Tips.....</b>	<b>19</b>
Before calling for service.....	19
Error codes.....	20
Technical information.....	21

# 1. IMPORTANT SAFETY INFORMATION

## READ ALL OF THE INSTRUCTIONS BEFORE USING

**▲ WARNING!** When using your dishwasher, follow the precautions listed below:



### GROUNDING INSTRUCTIONS

- This appliance must be grounded. In the event of a malfunction or breakdown, grounding will reduce the risk of an electric shock by providing a path of least resistance of electric current. This appliance is equipped with a cord having an equipment-grounding conductor and a grounding plug.
- The plug must be plugged into an appropriate outlet that is installed and grounded in accordance with all local codes and ordinances.

### ▲ WARNING!

- Improper connection of the equipment-grounding conductor can result in the risk of an electric shock.
- Check with a qualified electrician or service representative if you are in doubt whether the appliance is properly grounded. Do not modify the plug provided with the appliance; if it does not fit the outlet. Have a proper outlet installed by a qualified electrician.



### WARNING! PROPER USE

- Do not abuse, sit on, or stand on the door or dish rack of the dishwasher.
- Do not touch the heating element during or immediately after use.  
(This instruction is only applicable to machines with a visual heating element.)
- Do not operate your dishwasher unless all enclosure panels are properly in place. Open the door very carefully if the dishwasher is operating, there is a risk of water squirting out.
- Do not place any heavy objects on or stand on the door when it is open. The appliance could tip forward.
- When loading items to be washed:
  - 1) Locate sharp items so that they are not likely to damage the door seal;
  - 2) Warning: Knives and other utensils with sharp points must be loaded in the basket with their points down or placed in a horizontal position.
- When using your dishwasher, you should prevent plastic items from coming into contact with the heating element. (This instruction is only applicable to machines with a visual heating element.)
- Check that the detergent compartment is empty after completion of the wash cycle.
- Do not wash plastic items unless they are marked dishwasher safe or the equivalent. For plastic items not so marked, check the manufacturer's recommendations.
- Use only detergent and rinse additives designed for an automatic dishwasher.
- Never use soap, laundry detergent, or hand washing detergent in your dishwasher. Keep these products out of the reach of children.
- Keep children away from detergent and rinse aid, keep children away from the open door of the dishwasher, there could still be some detergent left inside.
- This appliance is not intended for use by persons (including children) with reduced physical, sensory or mental capabilities, or lack of experience and knowledge, unless they have been given supervision or instruction concerning use of the appliance by a person responsible for their safety.
- Children should be supervised to ensure that they do not play with the appliance.
- Dishwasher detergents are strongly alkaline, they can be extremely dangerous if swallowed. Avoid contact with skin and eyes and keep children away from the dishwasher when the door is open.
- The door should not be left open, since this could increase the risk of tripping.
- If the supply cord is damaged, it must be replaced by the manufacturer or its service agent or a similarly qualified person in order to avoid a hazard.
- Remove the door to the washing compartment when removing an old dishwasher from service or discarding it.
- Please dispose of packing materials properly.
- Use the dishwasher only for its intended function.
- During installation, the power supply must not be excessively or dangerously bent or flattened. Do not tamper with controls.
- The appliance is to be connected to the water mains using new hose sets and that old hose-sets should not be reused.
- The maximum number of place settings to be washed is 8.
- The maximum permissible inlet water pressure is 1Mpa.
- The minimum permissible inlet water pressure is 0.04Mpa.

**READ AND FOLLOW THIS SAFETY INFORMATION CAREFULLY**  
**SAVE THESE INSTRUCTIONS**

## 2. Operation Instruction

### IMPORTANT!

To get the best performance from your dishwasher, read all operating instructions before using it for the first time.

### Control Panel

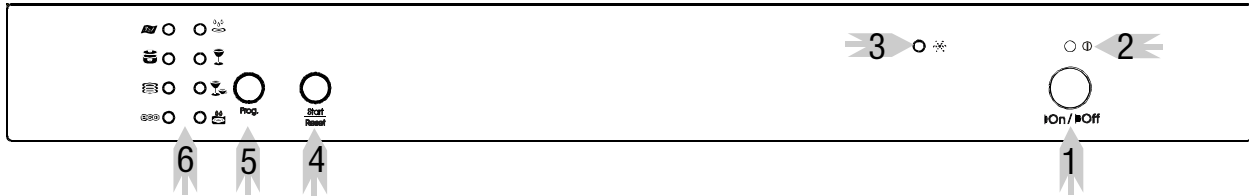

- |  |   |
|--|---|
| <ul style="list-style-type: none"> <li>1 ON/OFF Button: To turn on/off the power supply.</li> <li>2 Power Light : To come on when the ON/OFF Button is Pressed down.</li> <li>3 Rinse Aid Warning Light : To come on when the rinse aid dispenser needs to be refilled.</li> </ul> | <ul style="list-style-type: none"> <li>4 Start / Reset Button: Press this button to start or pause the dishwasher, the process pilot lamp will come on when starting.</li> <li>5 Program button: Press the button to choose the desired program.</li> <li>6 Program indicator light.</li> </ul> |
|--|---|

### Dishwasher Features

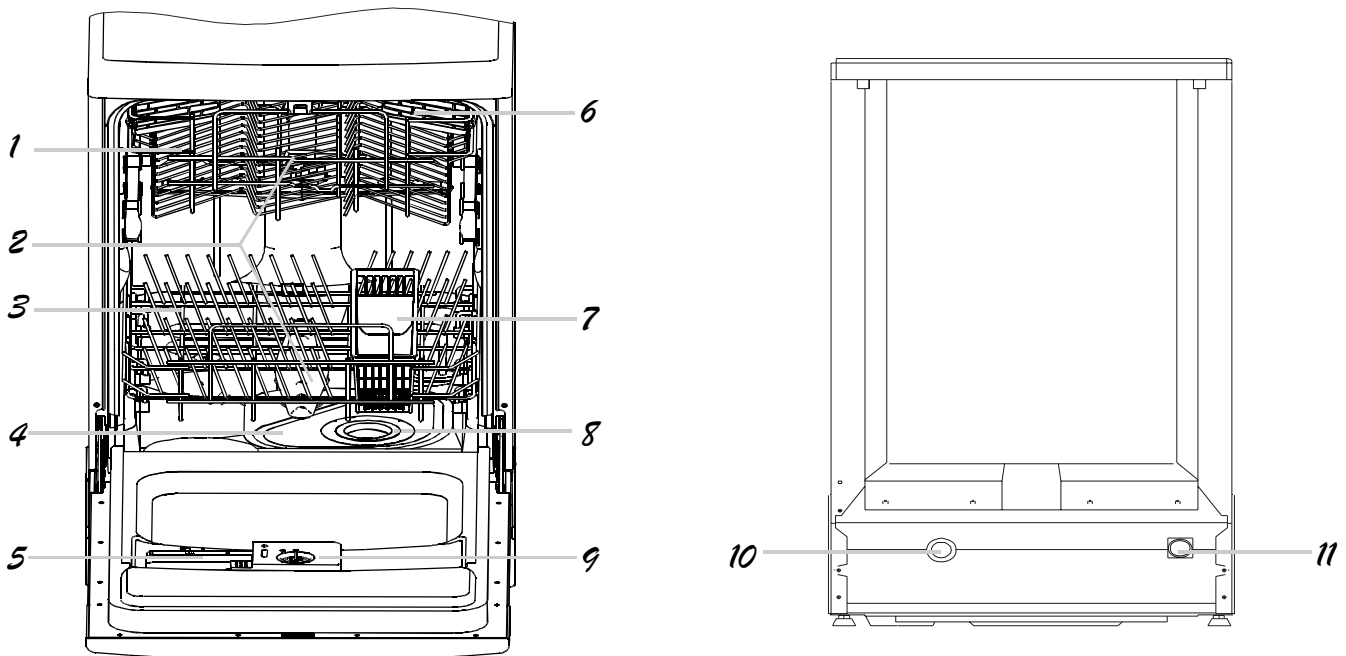

- |                |                       |                       |                         |
|----------------|-----------------------|-----------------------|-------------------------|
| 1 Upper Basket | 4 Main Filter         | 7 Silverware Basket   | 10 Drain pipe connector |
| 2 Spray Arms   | 5 Detergent Dispenser | 8 Coarse Filter       | 11 Inlet pipe connector |
| 3 Lower Basket | 6 Cup Shelf           | 9 Rinse Aid Dispenser |                         |

### 3. Prior using for the first time

Before using your dishwasher for the first time:

- A. Fill the rinse aid dispenser
- B. Fill in detergent

## A. Fill the Rinse Aid Dispenser

### Rinse Aid Dispenser

The rinse aid is released during the final rinse to prevent water from forming droplets on your dishes, which can leave spots and streaks. It also improves drying by allowing water to roll off the dishes. Your dishwasher is designed to use liquid rinse aids. The rinse aid dispenser is located inside the door next to the detergent dispenser. To fill the dispenser, open the cap and pour the rinse aid into the dispenser until the level indicator turns completely black. The volume of the rinse aid container is about 110ml.

### Function of Rinse Aid

Rinse aid is automatically added during the last rinse, ensuring thorough rinsing, and spot and streak free drying.

### Attention!

Only use branded rinse aid for dishwasher. Never fill the rinse aid dispenser with any other substances (e.g. Dishwasher cleaning agent, liquid detergent). This would damage the appliance.

### When to Refill the Rinse Aid Dispenser

If there is no rinse-aid warning light in the control panel, you can judge the amount of rinse-aid by the color of the optical level indicator "C" located next to the cap. When the rinse-aid container is full, the whole indicator will be dark. As the rinse-aid diminishes, the size of the dark dot decreases. You should never let the rinse aid get below 1 / 4 full.

As the rinse aid diminishes, the size of the black dot on the rinse aid level indicator changes, as illustrated below.

- Full
- 3 / 4 full
- 1 / 2 full
- 1 / 4 full – Should refill to eliminate spotting
- Empty

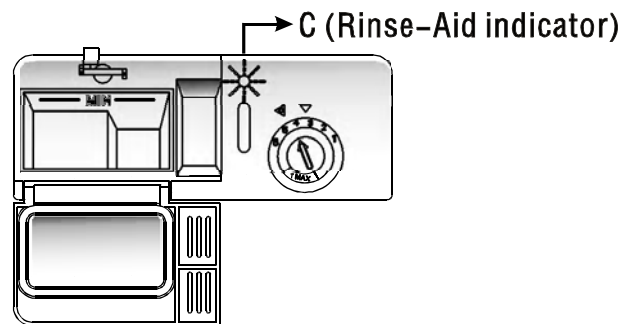

## RINSE AID DISPENSER

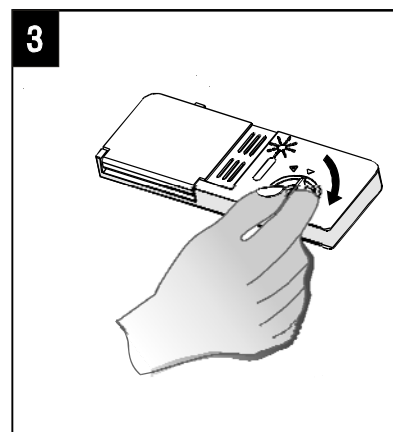
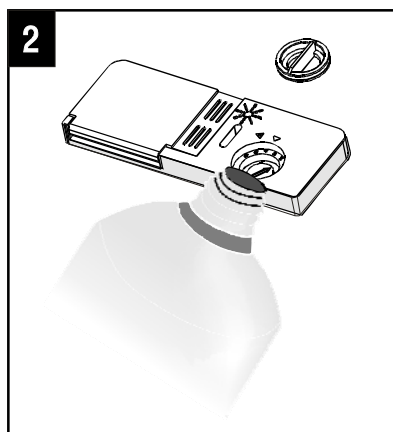
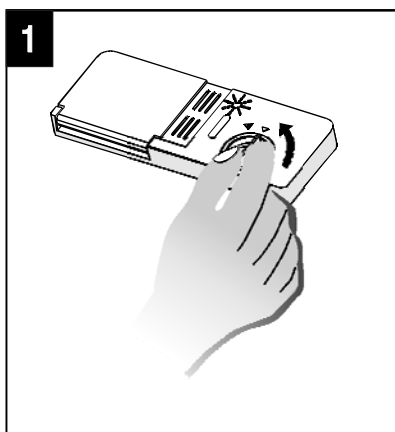

- 1** To open the dispenser, turn the cap to the "open" (left) arrow and lift it out.
- 2** Pour the rinse aid into the dispenser, being careful not to overfill.
- 3** Replace the cap by inserting it aligned with "open" arrow and turning it to the closed (right) arrow.

Be careful not to overfill the dispenser, because this could cause over sudsing. Wipe away any spills with a damp cloth. Don't forget to replace the cap before you close dishwasher door.

### Attention!

Clean up any rinse aid spill during filling with an absorbent cloth to avoid excess foaming during the next wash.

## Adjusting Rinse Aid Dispenser

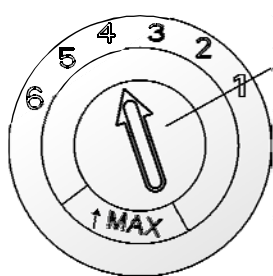

Adjust lever  
(Rinse)

The rinse aid dispenser has six scales. Always start with the dispenser set on "4". If spots and poor drying are a problem, increase the amount of rinse aid dispensed by removing the dispenser lid and rotating the dial to "5". If the dishes still are not drying properly or are show spots, adjust the dial to the next higher lever until your dishes are spot-free. The recommended setting is "4". (Factory value is "4".)



### NOTE:

Increase the dose if there are drops of water or lime spots on the dishes after washing. Reduce it if there are sticky whitish stains on your dishes or a bluish film on glassware or knife blades.

## B. Function of Detergent

Detergents with its chemical ingredients are necessary to remove dirt, crush dirt and transport it out of the dishwasher. Most of the commercial quality detergents are suitable for this purpose.

### Concentrated Detergent

Based on their chemical composition, detergents can be split in two basic types:

- conventional, alkaline detergents with caustic components
- low alkaline concentrated detergents with natural enzymes

The use of “normal” washing programs in combination with concentrated detergents reduces pollution and is good for your dishes; these wash programs are specifically matched to the dirt-dissolving properties of the enzymes of the concentrated detergent. For this reason “normal” wash programs in which concentrated detergents are used can achieve the same results that can otherwise only be achieved using “intensive” programs.

### Detergent Tablets

Detergent tablets of different brands dissolve at different speeds. For this reason some detergent tablets cannot dissolve and develop their full cleaning power during short programs. Therefore please use long programs when using detergent tablets, to ensure the complete removal of detergent residuals.

### Detergent Dispenser

The dispenser must be refilled before the start of each wash cycle following the instructions provided in the wash cycle table. Your dishwasher uses less detergent and rinse aid than Conventional dishwasher. Generally, only one tablespoon of detergent is needed for a normal wash load. More heavily soiled items need more detergent. Always add the detergent just before starting the dishwasher, otherwise it could get damp and will not dissolve properly.

### Amount of Detergent to Use

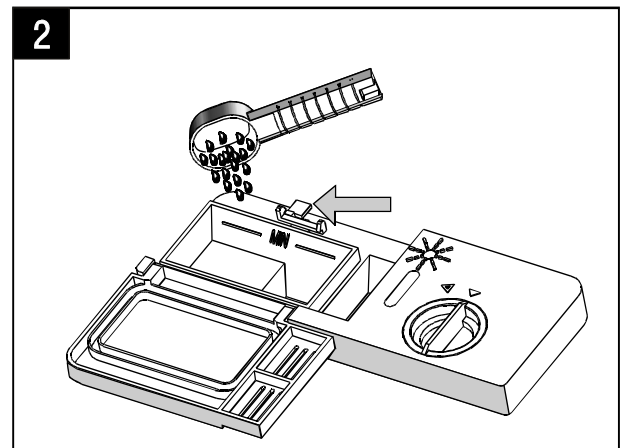
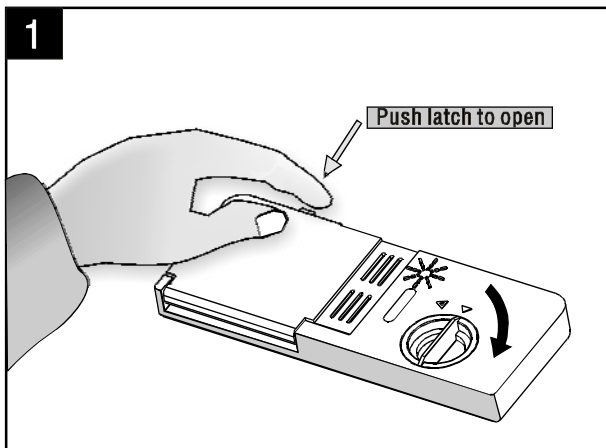

#### ! NOTE:

- If the lid is closed: press release button. The lid will spring open.
- Always add the detergent just before starting each wash cycle.
- Only use branded detergent aid for dishwasher.

#### ! WARNING! Dishwasher detergent is corrosive! Take care to keep it out of reach of children.

#### Proper Use of Detergent

Use only detergent specifically made for the use in dishwashers. Keep your detergent fresh and dry. Don't put powdered detergent into the dispenser until you're ready to wash dishes.

## Fill in detergent

Fill the detergent dispenser with detergent. The marking indicates the dosing levels, as illustrated on the right:

- A** The place of main wash cycle detergent placed, "MIN" means approximately 20g of detergent.
- B** The place of pre-wash cycle detergent placed, approximately 5g of detergent

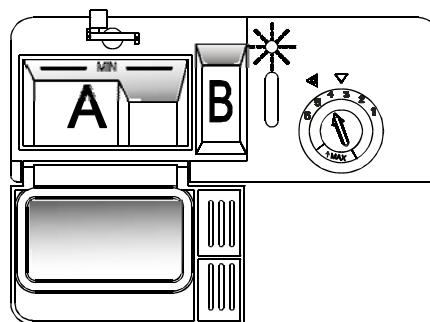

Please observe the manufacturers dosing and storage recommendations as stated on the detergent packaging.

Close the lid and press until it locks in place.

If the dishes are heavily soiled, place an additional detergent dose in the pre-wash detergent chamber. This detergent will take effect during the pre-wash phase.

### **NOTE:**

You find information about the amount of detergent for the single programmes on the last page. Please aware, that according to the level soiling and the specific hardness of water differences are possible.

Please observe the manufacturer's recommendations on the detergent packaging.

## Detergents

There are 3 sorts of detergents

1. With phosphate and with chlorine
2. With phosphate and without chlorine
3. Without phosphate and without chlorine

Normally new pulverised detergent is without phosphate. Thus the water softener function of phosphate is not given. In this case we recommend to fill salt in the salt container even when the hardness of water is only 6 °dH. If detergents without phosphate are used in the case of hard water often white spots appear on dishes and glasses. In this case please add more detergent to reach better results. Detergents without chlorine do only bleach a little. Strong and coloured spots will not be removed completely. In this case please choose a program with a higher temperature.

## Use of "2 in 1" , "3 in 1" , "4 in 1" and "5 in 1" Combination / Compact Detergents

**These products are detergents with integrated and combined detergent/rinse aid and salt functions. Before using these products you should first check that the water hardness in your supply is compatible with the use of these products as per the detergent manufacturers (on the product packaging). These products should be strictly used according to the detergent manufacturer's instructions. In general detergents that include rinse aid or water softener are only able to serve good results under certain conditions: rinse aid and water softener can not adapted to specific conditions. For this reasons in some cases there might be unwanted cleaning or drying results. Please ask the detergent manufacturer to inform you about the best consume conditions. If you encounter problems when using these products for the first time then please contact the detergent manufacturers care line. The manufacturer of your dishwasher is not liable for damages caused by compact detergents nor gives warranty if you use compact detergents.**

### **NOTE:**

**When use "2 in 1" , "3 in 1" , "4 in 1" or "5 in 1" Combination / Compact Detergents , please pay attention to make sure that the size of the Combination Detergents is fitted to the dispenser , so that Combination Detergents can be ease to put in the dispenser ,and dispenser would not be broken.**

## Attention

Keep all detergents in a safe place out of children's reach.  
Always add the detergent in the dispenser just before starting the dishwasher.



# How To Use The 3IN1 Function

Your dishwasher has a 3in1 function which needs no salt and rinse aid but a 3In1 tablet. This dishwasher comes with a 3in1 tablet container as an accessory.



**NOTE:** Only the 3in1 function (for the program: intensive/Normal/Eco.) Can be used with 3in1 tablets. If you use 3in1 tablets in other programs, the appliance will not achieve a good performance.

1. The figure below shows how to hang the 3in1 tablet container on the upper basket.

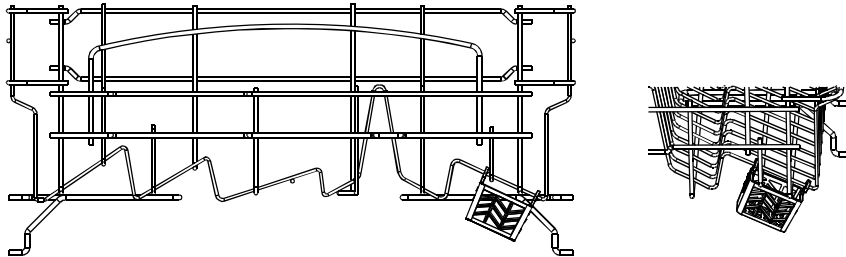

2. Rotate the upper sprayer and change the location of the container to ensure the upper sprayer is not obstructed by the 3in1 tablet container. Refer to the figure below for reference.

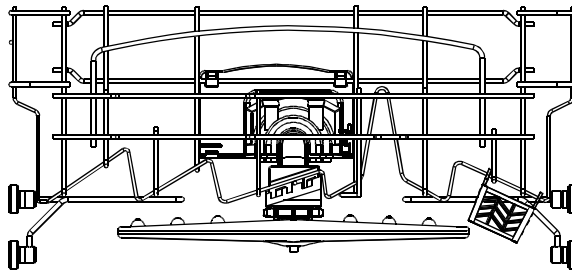

3. Put the 3in1 tablet into the container, then start the 3in1 program.



**NOTE:**

When using 3in1 combination / compact Detergents, please pay attention to make sure that the size of the combination detergents fits to the dispenser, so that combination detergents can be easily put into the dispenser, and the dispenser would not be broken.

## 4. Loading the Dishwasher Basket

For best performance of the dishwasher, follow these loading guidelines. Features and appearance of baskets and cutlery baskets may vary from your model.

### Attention before or after Loading the Dishwasher Baskets

Scrape off any large amounts of leftover food. Soften remnants of burnt food in pans.

It is not necessary to rinse the dishes under running water.

Place objects in the dishwasher in following way:

1. Items such as cups, glasses, pots/pans, etc. are faced downwards.
2. Curved items, or ones with recesses, should be loaded aslant so that water can run off.
3. All utensils are stacked securely and can not tip over.
4. All utensils are placed in the way that the spray arms can rotate freely during washing.

Very small items should not be washed in the dishwasher as they could easily fall out of the baskets.

### Removing the Dishes

To prevent water dripping from the upper basket into the lower back, we recommend that you empty the lower basket first and then the upper basket.

### Loading the Upper Basket

The upper basket is designed to hold more delicate and lighter dishware such as glasses, coffee and tea cup and saucers, as well as plates, small bowls and shallow pans (as long as they are not too dirty).

Position the dishes and cookware so that they do not get moved by the spray of water.

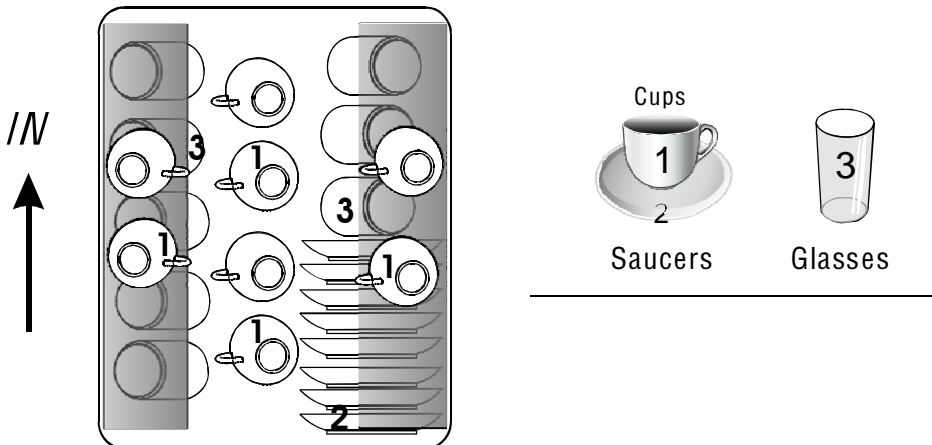

### Adjusting the Upper Basket

The height of the upper basket can be adjusted in order to create more space for large utensils both for the upper/lower basket. The height of the upper basket can be adjusted by placing the wheels on different height of the rails. Long items, serving cutlery, salad servers and knives should be placed on the shelf so that they do not obstruct the rotation of the spray arms. The shelf can be folded back or be removed when not required for use.

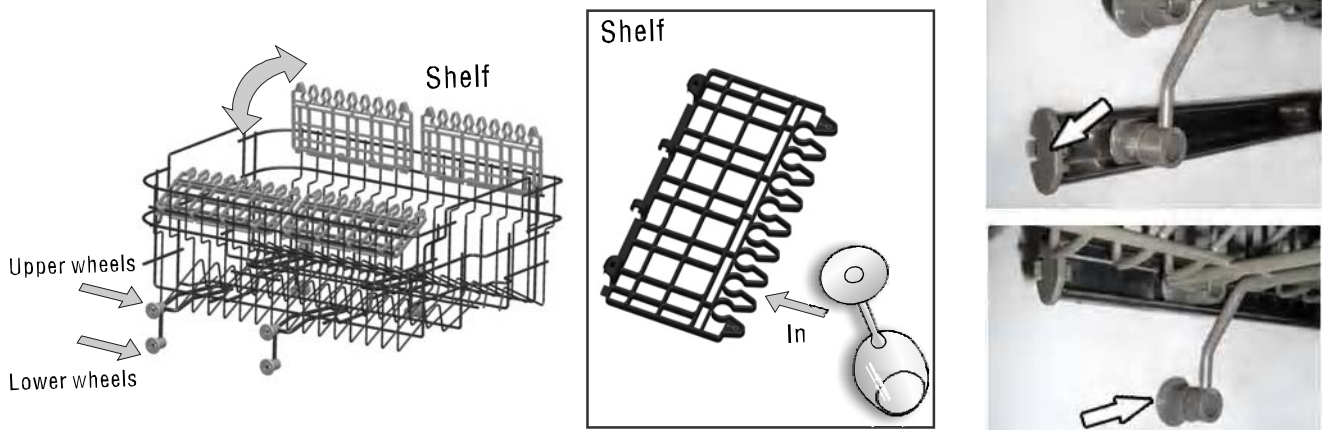

# Loading the Lower Basket

We recommend that you place large items which are most difficult to clean into the lower basket: pots, pans, lids, serving dishes and bowls, as shown in the figure to the right. It is preferable to place serving dishes and lids on the side of the racks in order to avoid blocking the rotation of the top spray arm.

Pots, serving bowls, etc. must always be placed top down.  
Deep pots should be slanted to allow water to flow out.  
The bottom basket feature fold down tine rows so that larger or more pots and pans can be loaded.

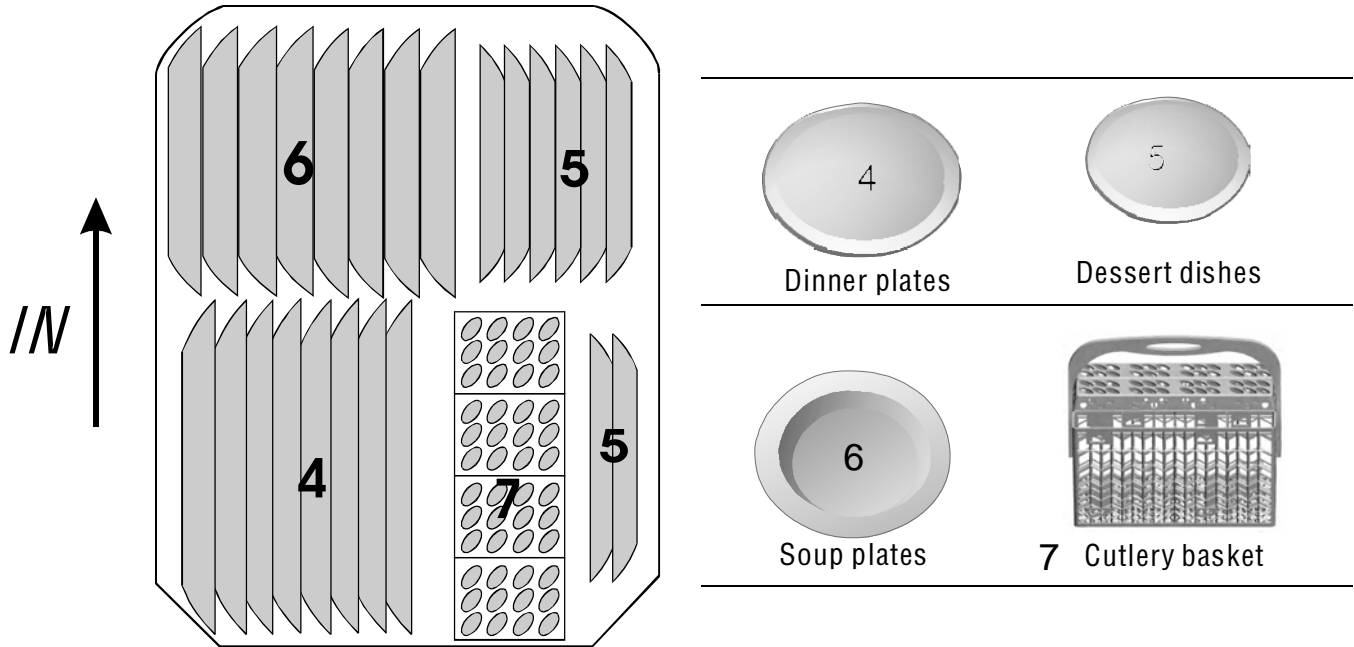

## Folding spikes



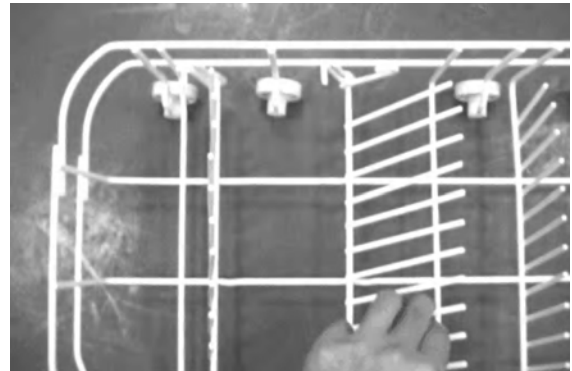

For better stacking of pots and pans, the spikes can be folded down as show in the picture right.

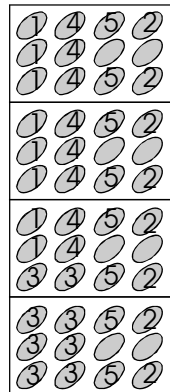
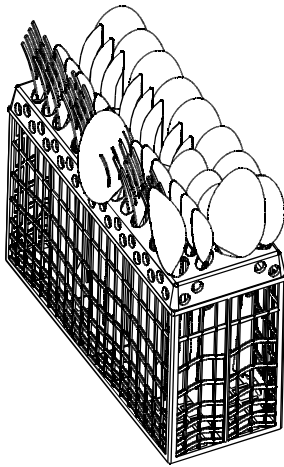

# Cutlery Basket

Cutlery should be placed in the cutlery basket with the handles at the bottom. If the rack has side baskets, the spoons should be loaded separately into the appropriate slots, especially long utensils should be placed in the horizontal position at the front of the upper basket as shown in the picture.



- |   |                |   |
|---|----------------|---|
| 1 | Forks          |  |
| 2 | Soup spoons    |  |
| 3 | Dessert spoons |  |
| 4 | Teaspoons      |  |
| 5 | Knives         |  |



## ⚠ WARNING!

- Do not let any item extend through the bottom.
- Always load sharp utensils with the sharp point down!

For washing in the dishwasher the following cutlery/dishes

### Are not suitable

- Cutlery with wooden, horn china or mother-of-pearl handles
- Plastic items that are not heat resistant
- Older cutlery with glued parts that are not temperature resistant
- Bonded cutlery items or dishes
- Pewter or cooper items
- Crystal glass
- Steel items subject to rusting
- Wooden platters
- Items made from synthetic fibres

#### NOTE:

Do not put in items that are dirty of cigarette ash, candle wax, lacquer or paint. If you buy new dishes please make sure that they are suitable for dishwashers.

#### NOTE:

Please do not overload your dishwasher. Do not use dish that is not suitable for dishwashers. This is important for good results and for reasonable energy consume.

#### Loading cutlery and dishes

Before loading the dishes, you should:  
 Remove large left-over  
 Soften remnants of burnt food in pans

#### When loading the dishes and cutlery, please note:

Dishes and cutlery must not impede the rotation of the spray arms  
 Load hollow items such as cups, glasses, pans etc. with the opening downwards so that water cannot collect in the container or a deep base

### Are of limited suitability

Some types of glasses can become dull after a large number of washes

Silver and aluminum parts have a tendency to discolour during washing

Glazed patterns may fade if machine washed frequently

- Dishes and items of cutlery must not lie inside one another, or cover each other
- To avoid damage to glasses, they must not touch
  - Load large items which are most difficult to clean into the lower rack
  - The upper rack is designed to hold more delicate and lighter dishware such as glasses, coffee and tea cups

## **Attention!**

Long bladed knives stored in an upright position are a potential hazard!  
Long and/or sharp items of cutlery such as carving knives must be positioned horizontally in the upper basket.

Damage to glassware and other dishes

## **Possible causes:**









- Type of glass or manufacturing process. Chemical composition of detergent.
- Water temperature and duration of dishwasher programme.

## **Suggested remedy:**

- Use glassware or porcelain dishes that have been marked dishwasher-proof by the manufacturer
- Use a mild detergent that is described as kind of dishes. If necessary, seek further information from detergent manufacturers.
- Select a programme with as low a temperature.
- To prevent damage, take glass and cutlery out of the dishwasher as soon as possible after the programme has ended.

## 5. Starting a washing programme

### WASH CYCLE TABLE

Program	Cycle Selection Information	Description of Cycle	Detergent pre/main	Running time(min)	Energy (Kwh)	Water (l)	Rinse Aid
 3 In1	For normally soiled loads, such as pots, plates, glasses and lightly soiled pans. standard daily cycle.	Pre-wash pre-wash wash(45 °C) rinse(70 °C) drying	3in1	160	0.95	14.7	
 Intensive	For the heaviest soiled loads, such as pots, pans, casserole dishes and dishes that have been sitting with dried food on them for a while.	Pre-wash Pre-wash(50 °C) Wash (60 °C) Rinse (70 °C) Drying	4/20 g.	160	1.10	12.9	★
 Normal (AS/NZS2007.1)	For normally soiled loads, such as pots, plates, glasses and lightly soiled pans. standard daily cycle.	Pre-wash Pre-wash Wash (50 °C) Rinse (65 °C) Drying	4/20 g.	155	0.74	12.9	★
 Eco	For lightly soiled loads, such as plates, glasses, bowls and lightly soiled pans.	Pre-wash Wash (45 °C) Rinse (60 °C) Drying	20g.	105	0.65	10.2	★
 Rinse	For dishes that need to be rinsed and dried only.	Wash(45 °C) Rinse (70 °C) Drying		95	0.75	7.5	★
 Glass	For lightly soiled loads, such as glasses, crystal and fine china.	Pre-wash wash(40 °C) rinse(70 °C) drying	15 g.	110	0.75	10.2	★
 Rapid	A shorter wash for lightly soiled loads that do not need drying.	Wash (40 °C) Rinse (45 °C)	15 g.	30	0.35	6.5	
 Soak	To rinse dishes that you plan to wash later that day.	Pre-wash		8	0.01	2.8	

## Turning on the Appliance

Starting a wash cycle...

- 1 Draw out the lower and upper basket, load the dishes and push them back. It is commended that loading the lower basket first, than the upper one (see the section entitled "Loading the Dishwasher" ).
- 2 Pour in the detergent (see the section entitled "Salt, Detergent and Rinse Aid" ).
- 3 Insert the plug into the socket. The power supply is 220–240 VAC 50 HZ, the specification of the socket is 10 A 250 VAC. Make sure that the water supply is turned on to full pressure.
- 4 When select 6 kinds of wash program  
Press the programme button, the wash program will change as follows direction  
3in1->Intensive->Normal->Eco->Rinse->Glass->Rapid->Soak;  
When a program is selected, the response light will light. Then press the Start/Reset button, the program is running.

**Note: When you press the Start/Reset button to pause during washing, the program light will stop blinking and the dishwasher will mooring every minute unless you press the Start/Reset button to start.**

## Change the Programme . . .

Premise: You can modified the washing program, just the dishwasher has been running for a short time. Otherwise, the detergent may have already been released, and the appliance may have already drained the wash water. If this is the case, the detergent dispenser must be refilled (see the section entitled " Loading the Detergent " ).

Press start/Reset Button more than three seconds the machine will be in stand by state ,then you can change the program to the desired cycle setting (see the section entitled " Starting a wash cycle. . . " ).

NOTE: If you open the door when washing, the machine will pause. When you close the door and press the start/reset Button, the machine will keep on working after 10 seconds.

The program lights shows the state of the dishwasher:

- a) All program lights off-----stand by
- b) One of the program lights on-----pause
- c) One of the program lights blinking----- run

**NOTE:**

If all the lights begin to glimmer, that indicates the machine is out of order, please turn off the main power and water supply before calling a service.

## Forget to Add a Dish?

A forgotten dish can be added at any time before the detergent cup opens.

- 1 Open the door a little to stop the washing.
- 2 After the spray arms stop working, you can open the door completely.
- 3 Load the forgotten dishes.
- 4 Close the door, the dishwasher will start running again after 10 seconds.

### **▲ WARNING!**

It is dangerous to open the door when washing, because the hot water may scald you.

## At the End of the Wash Cycle

When the working cycle has finished, the buzzer of the dishwasher will sound for 8 seconds, then stop. Turn off the appliance using the ON/OFF button, shut off the water supply and open the door of the dishwasher. Wait for a few minutes before unloading the dishwasher to avoid handling the dishes and utensils while they are still hot and more susceptible to breakage. They will also dry better.

## ■ Switch Off the Dishwasher

In the digital display appears 0 (remaining programme time), only in this case the programme has ended.

1. Switch off the dishwasher by pressing the ON/OFF button.

2. Turn off the water tap!

## ■ Open the door carefully.

Hot dishes are sensitive to knocks. The dishes should therefore be allowed to cool down around 15 minutes before removing from the appliance.

Open the dishwasher's door, leave it ajar and wait a few minutes before removing the dishes. In this way they will be cooler and the drying will be improved.

## ■ Unloading the dishwasher

It is normal that the dishwasher is wet inside.

Empty the lower basket first and then the upper one. This will avoid water dripping from the upper Basket onto the dishes in the lower one.

# 6. Maintenance and Cleaning

## Filtering System

The filter prevents larger remnants of food or other objects from getting inside the pump.  
The residues may block the filter, in this case they must be removed.

The filter system consists of a coarse filter, a flat (Main filter) And a microfilter (Fine filter).

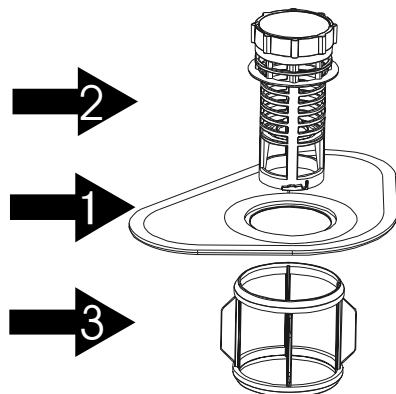

### Main filter **1**

Food and soil particles trapped in this filter are pulverized by a special jet on the lower spray arm and washed down the drain.

### Coarse filter **2**

Larger items, such as pieces of bones or glass, that could clog the drain are trapped in the coarse filter. To remove an item caught in this filter, gently squeeze the taps on the top of this filter and lift it out.

### Fine filter **3**

This filter holds soil and food residues in the sump area and prevents it from being redeposit on the dishes during a cycle.

- Inspect the filters for blocking after every time the dishwasher has been used.
- By unscrewing the coarse filter, you can remove the filter system. Remove any food remnants and clean the filters under running water.

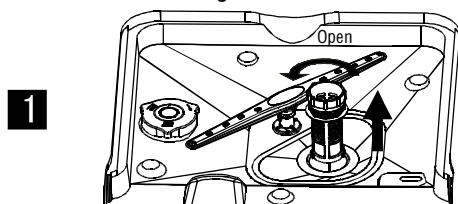

step 1 : Turn the filter in anti-clockwise direction, then lift it up

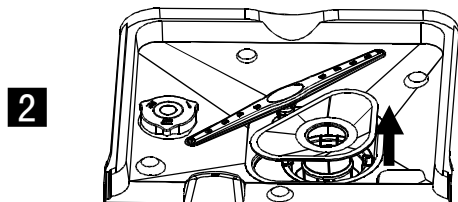

step 2 : lift the Main filter up

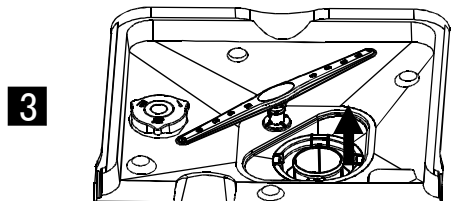

step 3: lift the Fine filter up

### NOTE:

When following this procedure from step1 to step 3, the filter system will be removed;  
when following it from Step 3 to Step 1, the filter system will be installed.



## Filter assembly

For best performance and results, the filter assembly must be cleaned. The filter efficiently removes food particles from the wash water, allowing it to be recycled during the cycle. For best performance and results, the filter must be cleaned regularly. For this reason, it is a good idea to remove the larger food particles trapped in the filter after each wash cycle by rinsing the semicircular filter and cup under running water. To remove the filter device, pull the cup handle in the upward direction. The entire filter assembly should be cleaned once a week.

To clean the coarse filter and the fine filter, use a cleaning brush. Then, reassemble the filter parts as shown in the figures left and reinsert the entire assembly in the dishwasher, positioning in its seat and pressing downward.

The dishwasher must never be used without the filters. Improper replacement of the filter may reduce the performance level of the appliance and damage dishes and utensils.

### **▲ WARNING!**

- The dishwasher must never be used without the filters.
- Improper replacement of the filter may reduce the performance level of the appliance and damage dishes and utensils.

## Cleaning the Spray Arms

It is necessary to clean the spray arms regularly for hard water chemicals will clog the spray arm jets and bearings.

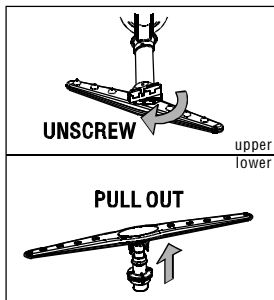

### Remove the upper spray arms

To remove the upper spray arms, screw off the nut clockwise to take out the washer on top of the spray arm and remove the arm.

### Remove the lower spray arms

To remove the lower spray arm, pull out the spray arm upward.

### Wash the arms

Wash the arms in soapy and warm water and use a soft brush to clean the jets. Replace them after rinsing them thoroughly.

## Caring for the Dishwasher

The control panel can be cleaned by using a lightly dampened cloth.

After cleaning, make sure to dry it thoroughly.

For the exterior, use a good appliance polish wax.

Never use sharp objects, scouring pads or harsh cleaners on any part of the dishwasher.

## Protect Against Freezing

please take frost protection measures on the dishwasher in winter. Every time after washing cycles, please operate as follows:

1. Cut off the electrical power to the dishwasher.
2. Turn off the water supply and disconnect the water inlet pipe from the water valve.
3. Drain the water from the inlet pipe and water valve. (Use a pan to catch the water)
4. Reconnect the water inlet pipe to the water valve.
5. Remove the filter at the bottom of the tub and use a sponge to soak up water in the sump.

## Cleaning the Door

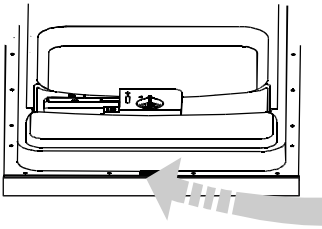

To clean the edge around the door, you should use only a soft warm, damp cloth. To avoid penetration of water into the door lock and electrical components, do not use a spray cleaner of any kind.

### **⚠ WARNING!**

- Never use a spray cleaner to clean the door panel as it may damage the door lock and electrical components.
- Abrasive agents or some paper towels should not be used because of the risk of scratching or leaving spots on the stainless steel surface.

## How to Keep Your Dishwasher in Shape

### ■ *After Every Wash*

After every wash, turn off the water supply to the appliance and leave the door slightly ajar so that moisture and odours are not trapped inside.

### ■ *Remove the Plug*

Before cleaning or performing maintenance, always remove the plug from the socket. Do not run risks.

### ■ *No Solvents or Abrasive Cleaning*

To clean the exterior and rubber parts of the dishwasher, do not use solvents or abrasive cleaning products. Rather, use only a cloth and warm soapy water. To remove spots or stains from the surface of the interior, use a cloth dampened with water and a little vinegar, or a cleaning product made specifically for dishwashers.

### ■ *When not in Use for a Long Time*

When you go on holiday, it is recommend that you run a wash cycle with the dishwasher empty and then remove the plug from the socket, turn off the water supply and leave the door of the appliance slightly ajar. This will help the seals to last longer and prevent odours from forming within the appliance.

### ■ *Moving the Appliance*

If the appliance must be moved, try to keep it in the vertical position. If absolutely necessary, it can be positioned on its back.

### ■ *Seals*

One of the factors that cause odours to form in the dishwasher is food that remains trapped in the seals. Periodic cleaning with a damp sponge will prevent this from occurring.

## 7. Installation instruction

### About Power Connection

#### **⚠ WARNING!**

For personal safety:

- DO NOT USE AN EXTENSION CORD OR AN ADAPTER PLUG WITH THIS APPLIANCE.
- DO NOT, UNDER ANY CIRCUMSTANCES, CUT OR REMOVE THE EARTHING CONNECTION FROM THE POWER CORD.

### Electrical Requirements

Please look at the rating label to know the rating voltage and connect the dishwasher to the appropriate power supply. Use the required fuse 10 amp, time delay fuse or circuit breaker recommended and provide separate circuit serving only this appliance.

### Electrical Connection

#### **⚠ Insure proper ground exists before use**

Ensure the voltage and frequency of the power being corresponds to those on the rating plate. Only insert the plug into an electrical socket which is earthed properly. If the electrical socket to which the appliance must be connected is not appropriate for the plug, replace the socket, rather than using a adaptors or the like as they could cause overheating and burns.



### GROUNDING INSTRUCTIONS

- This appliance must be earthed. In the event of a malfunction or breakdown, earthing will reduce the risk of electric shock by providing a path of least resistance for the electric current. This appliance is equipped with a cord having an equipment–earthing conductor and an earthing plug. The plug must be plugged into an appropriate outlet that is installed and earthed in accordance with all local standards and requirements.

- ⚠ WARNING!**
- Improper connection of the equipment earthing conductor can result in the risk of an electric shock.
  - Check with a qualified electrician or service representative if you are in doubt whether the appliance is properly earthed.
  - Do not modify the plug provided with the appliance. If the plug does not fit properly to the outlet, please have a qualified electrician to install a proper outlet.

## Water Connection

### Cold Water Connection

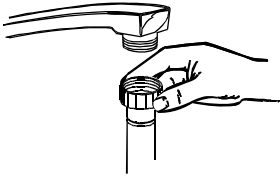

Connect the cold water supply hose to a threaded 3/4 (inch) connector and make sure that it is fastened tightly in place. If the water pipes are new or have not been used for an extended period of time, let the water run to make sure that the water is clear. This precaution is needed to avoid the risk of the water inlet to be blocked and damage the appliance.

### Hot Water Connection

The water supply to the appliance can also be connected to the household hot water line (such as, central system, heating system), as long as it does not exceed a temperature of 60°C. In this case, the wash cycle time will be shortened by about 15 minutes and the wash efficiency slightly reduced.

The connection must be made to the hot water line following the same procedures as described in the section for the connection to the cold water line.

- ⚠ WARNING!** In order to avoid that there is more water staying in the inlet hose, please close the hydrant after using. (Not applicable to appliances without aqua-stop.)

### Drain hose Connection

Insert the drain hose into a drain pipe with a minimum diameter of 4 cm, or let it run into the sink, making sure to avoid bending or crimping. Use the special plastic support that comes with the appliance. The free end of the hose must be at a height between 40 and 100cm and must not be immersed in water.

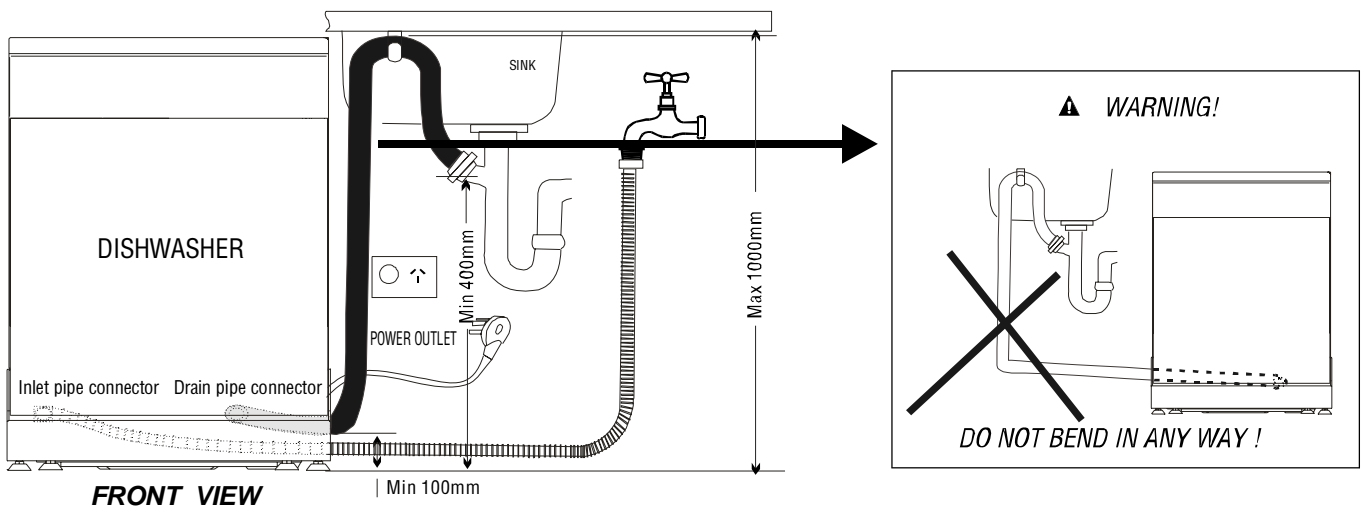

## Positioning the Appliance

Position the appliance in the desired location. The back should rest against the wall behind it, and the sides, along the adjacent cabinets or walls. The dishwasher is equipped with water supply and drain hoses that can be positioned either to the right or the left sides to facilitate proper installation.

### *Levelling the Appliance*

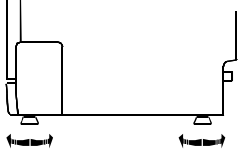

Once the appliance is positioned for levelling, the height of the dishwasher may be altered via adjustment of the screwing level of the feet. In any case, the appliance should not be inclined more than 2°.

## Water Outlet

Connect the water drain hose. The drain hose must be correctly fitted to avoid water leaks. Ensure that the water drain hose is not kinked or squashed.

## Extension Hose

If you need a drain hose extension, make sure to use a similar drain hose. It must be no longer than 4 metres; otherwise the cleaning effect of the dishwasher could be reduced.

## Syphon Connection

The waste connection must be at a height of between 40 cm (minimum) and 100 cm (maximum) from the bottom of the dish. The water drain hose should be fixed by a hose clip. The free end of the hose must not be immersed in water.

## Start of Dishwasher

The following things should be checked before starting the dishwasher.

- 1** The dishwasher is level and fixed properly
- 2** The inlet valve is open
- 3** There is a leakage at the connections of the conducts
- 4** The wires are tightly connected
- 5** The power is switched on
- 6** The inlet and drain hoses are knotted
- 7** All packing materials and printings should be taken out from the dishwasher



**Attention:** After installation, please make sure to keep this manual.

The content of this manual is very helpful to the users.

## 8. Troubleshooting Tips

### Before Calling for Service

Review the charts on the following pages may save you from calling for service.



	<i>Problem</i>	<i>Possible Causes</i>	<i>What To Do</i>
Technical problems	<i>Dishwasher doesn't start</i>	Fuse blown, or the circuit breaker acted	Replace fuse or reset circuit breaker. Remove any other appliances sharing the same circuit with the dishwasher
		Power supply is not turned on	Make sure the dishwasher is turned on and the door is closed securely. Make sure the power cord is properly plugged into the wall socket.
		Error code:E1; Water pressure is low	Check that the water supply is connected properly and the water is turned on.
		Door of dishwasher not properly closed.	Make sure to close the door properly and latch it.
	<i>water not pumped from dishwasher</i>	Kink in drain hose	Check drain hose.
		Filter clogged	Check coarse the filter (see section titled " Cleaning The Filter ")
		Kitchen sink clogged	Check the kitchen sink to make sure it is draining well. If the problem is the kitchen sink not draining ,you may need a plumber rather than a serviceman for dishwashers.
General problems	<i>Suds in the tub</i>	Improper detergent	Use only the special dishwasher detergent to avoid suds. If this occurs, open the dishwasher and let suds evaporate. Add 1 gallon of cold water to the tub. Close and latch the dishwasher, then Start the "soak" wash cycle to drain out the water . Repeat if necessary.
		Spilled rinse-aid	Always wipe up rinse-aid spills immediately.
	<i>Stained tub interior</i>	Detergent with colourant was used	Make sure that the detergent is the one without colourant.
	<i>White film on inside surface</i>	Hard water minerals	To clean the interior, use a damp sponge with dishwasher detergent and wear rubber gloves. Never use any other cleaner than dishwasher detergent for the risk of foaming or suds.
		<i>There are rust stains on cutlery</i>	The affected items are not corrosion resistant.
			A programme was not run after dishwasher salt was added. Traces of salt have gotten into the wash cycle.
Noise	<i>Knocking noise in the wash cabinet</i>	The lid of the softer is loose	Check the lip .Ensure the fix is fine.
		A spray arm is knocking against an item in a basket	Interrupt the programme, and rearrange the items which are obstructing the spray arm.
	<i>Rattling noise in the wash cabinet</i>	Items of crockery are loose in the wash cabinet	Interrupt the programme, and rearrange the items of crockery.
	<i>Knocking noise in the water pipes</i>	This may be caused by on-site installation or the cross-section of the piping.	This has no influence on the dishwasher function. if in doubt, contact a suitably qualified plumber.



Unsatis-  
-factory  
washing  
result

<i>Problem</i>	<i>Possible Causes</i>	<i>What To Do</i>
<i>The dishes are not clean</i>	The dishes were not loaded correctly.	See notes in " Loading the Dishwasher Baskets ".
	The programme was not powerful enough.	Select a more intensive programme. See " Wash Cycle Table ".
	Not enough detergent was dispensed.	Use more detergent, or change your detergent.
	Items are blocking the path of spray arms.	Rearrange the items so that the spray can rotate freely.
	The filter combination in the base of wash cabinet is not clean or is not correctly fitted. This may cause the spray arm jets to get blocked.	Clean and/or fit the filter combination correctly. Clean the spray arm jets. See "Cleaning the Spray Arms".
<i>Cloudiness on glassware</i>	Combination of soft water and too much detergent.	Use less detergent if you have soft water and select a shortest cycle to wash the glassware and to get them clean.
<i>Black or gray marks on dishes</i>	Aluminum utensils have rubbed against dishes.	Use a mild abrasive cleaner to eliminate those marks.
<i>Detergent left in dispenser cups</i>	Dishes block detergent cups.	Re-loading the dishes properly.

Unsatis-  
-factory  
drying  
result

<i>The dishes are not drying</i>	Improper loading	Load the dishwasher as suggested in the directions.
	Too little rinse-aid	Increase the amount of rinse-aid/refill the rinse-aid dispenser.
	Dishes are removed too soon	Do not empty your dishwasher immediately after washing. Open the door slightly so that the steam can escape. Begin unloading the dishwasher only once the dishes are barely warm to the touch. Empty the low basket first. This prevents water from dropping off dishes in the upper basket.
	Wrong program has been selected	In short program the washing temperature is lower. This also lowers cleaning performance. Choose a program with a long washing time.
	Use of cutlery with a low-quality coating	Water drainage is more difficult with these items. Cutlery or dishes of this type are not suitable for washing in the dishwasher.

## ERROR CODES

*When some malfunctions come on, the appliance will display error codes to warn you:*

<i>Codes</i>	<i>Meanings</i>	<i>Possible Causes</i>
<i>The Eco light flicker fleetly</i> ☹	Longer inlet time.	Faucets is not opened, or water intake is restricted, or water pressure is too low.
<i>The normal light and Eco flicker fleetly</i> ☹ + ☹	Longer heating time, but not reaching required temperature	Malfuction of temperature sensor or of heating element.
<i>The Intensive light flicker fleetly</i> ☹	Overflow.	Some element of dishwasher leaks .
<i>The Intensive light and normal light flicker fleetly</i> ☹ + ☹	Failure of temperature sensor	Short circuit or break of temperature sensor
<i>The Intensive light , normal light and Eco light flicker fleetly</i> ☹ + ☹ + ☹	Failure of temperature sensor	Open circuit or break of temperature sensor

### ⚠ WARNING!

- If overflow occurs, turn off the main water supply before calling a service.
- If there is water in the base pan because of an overflow or small leak, the water should be removed before restarting the dishwasher.

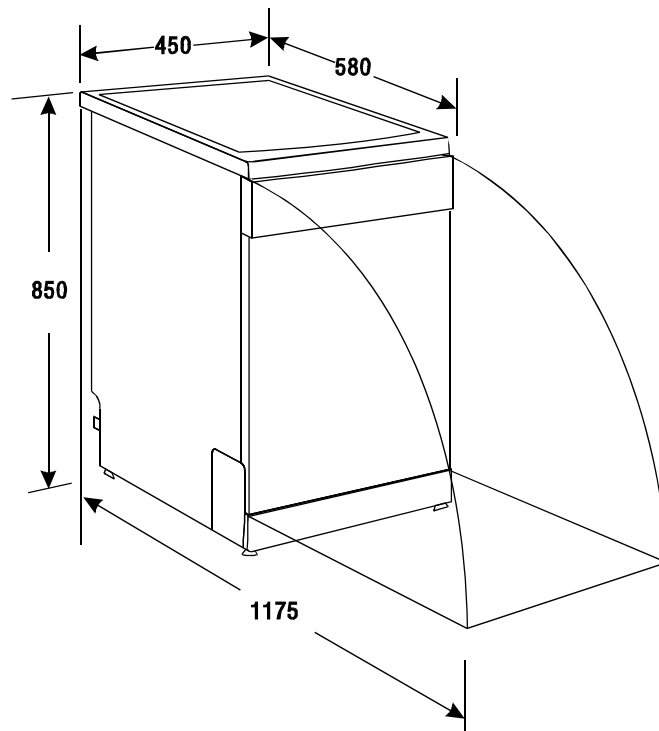

Height :	850mm
Width :	450mm
Depth :	580mm
Voltage connected Load :	see rating label
Water pressure:	0.04–1.0MPa
Hot water connection :	max 60 °C
Power supply:	see rating label
Capacity:	8 Place settings

## THIS WARRANTY IS VALID IN NEW ZEALAND ONLY

**Note:**

Please complete the following details when you unpack the product and return the bottom portion of this card to:

**Applico Ltd**  
**Private Bag 92-900**  
**Onehunga**  
**Auckland, New Zealand**

**Warranty:**

These products are covered by a warranty for a period of 24 months from the date of purchase, subject to the following conditions\*. The Warranty covers rectification free of charge of any fault arising from defective materials or components, or faulty workmanship or assembly.

\* The conditions above mentioned are:

1. that the purchaser carefully follows all instructions packed with the product;
2. that the purchaser carefully follows the installation instructions provided and complies with electrical wiring regulations, gas and or plumbing codes;
3. that the purchaser carefully follows instructions provided in the owner's handbook relating to the proper use and care of the product and does not use the product for any purpose other than the domestic use for which it has been designed;
4. all appliances being used in a non residential commercial situation are covered by a 3 month warranty from the original date of purchase;
5. that the product was purchased and installed in New Zealand;
6. that this warranty does not extend to:
  - a) optional glass lids for hobs apart from claims which relate to mechanical or physical damage thereof at the date of purchase;
  - b) light bulbs
  - c) damage to ceramic glass caused by liquid or solid spillovers, lack of maintenance, or impact;

- d) damage to surface coatings caused by cleaning or maintenance using products not recommended by the owner's handbook;
  - e) defects caused by normal wear and tear, accident, negligence, alteration, misuse or incorrect installations;
  - f) a product dismantled, repaired or serviced by any serviceman other than an authorised service agent;
  - g) a product not in possession of the original purchaser;
7. that if the product is a microwave or small appliance it must be returned to the dealer for servicing. These products, unless stated otherwise have a 12 month warranty from original date of purchase with 24 months on the microwave magnetron; Waste disposers have a 24 month warranty;
  8. The provision of service under this Warranty is limited by a 25km boundary from the retailer where the product was purchased. Such travelling outside of these limits will incur commercial cost to be paid by you, regulated by the number of kilometres travelled beyond the 25km limit (50km return trip).

Nothing herein contained shall be construed in any way as excluding or limiting your rights under the Consumer Guarantees Acts 1993.

For service please contact the dealer/retailer from whom you purchased the product. If you are unable to establish the date of purchase, or the fault is not covered by this Warranty, or if the product is found to be in working order, you will be required to bear all service call charges.

**Note: Completion of this Warranty Registration Card constitutes acceptance of the terms and conditions of this Warranty.**

**Distributed by Applico Ltd**  
**www.applico.co.nz**

**Please complete this section, detach and post to:**  
**Applico Warranty, Private Bag 92-900, Onehunga, Auckland**  
**or register online at [www.applico.co.nz](http://www.applico.co.nz)**

**PRODUCT TYPE:**..... **MODEL NO:**.....

**SERIAL NO:** ..... **DATE OF PURCHASE:** .....

**RETAILER:**..... **INVOICE/SALES DOCKET NO:**.....

**RETAILER ADDRESS:** .....

**PURCHASERS' NAME:** .....

**ADDRESS:**.....



---

**Affix  
stamp  
here**

**Applico Ltd  
Warranty Department  
Private Bag 92-900  
Onehunga  
Auckland**