

RANGEHOODS

INTEGRATED RANGEHOOD 900



Colour:	White
Model:	URI9WE1
Dimensions:	865mm (W) x 287mm (D) x 380mm (H)
Packaging:	Carton Size: 910mm (W) x 440mm (D) x 325mm (H) Carton Cubic Metres: 0.13 cubic metres Carton Weight: 17kg
Motor:	Single, 198 watts
Airflow:	Airflow = max. 760m ³
Sound Level:	Max. 56dBA
Controls:	Backlit electronic push button, 3 speed
Features:	<ul style="list-style-type: none"> • Teflon coated blades • Oil catchment cup
Lamps:	2 x 10W Halogen
Grease Filter:	1 x Aluminium mesh (Require cleaning as least once a month)
Ducting:	Top Only (for details refer to the Ducting Specification Sheets under Accessories on the website) also see following page for ducting methods applicable.*
Ducting Spigot:	150mm
Re-circulating:	Only through to top of cupboard or through a bulkhead. In re-circulation ducting is required and fitted between the ducting spigot and top of cupboard or through the bulkhead. A mesh cover is recommended to keep out rodent or insects.
Carbon Filters:	Code IXFC4 (2 required) - available to purchase on 1800 805 300.
Minimum Height Above Cooktop:	Gas: 650mm Electric: 600mm
Method of Installation:	Integrated - Attached and suspended off cabinet back, concealed behind cupboard doors.
Power Requirement:	240V 10 amps

* Ducting supplied by installer

RANGEHOOD DIMENSIONS

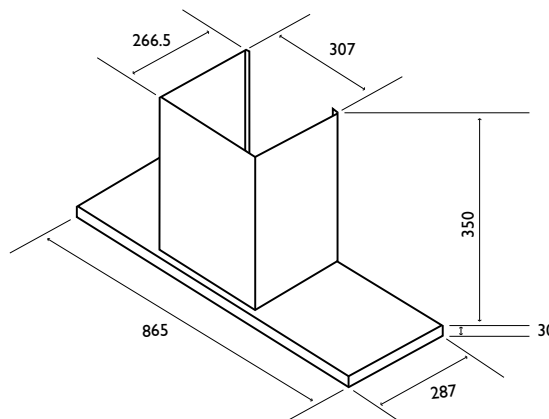

RANGEHOODS

INTEGRATED
RANGEHOOD
900

DUCTING & RE-CIRCULATING INSTALLATION OPTIONS FOR INTEGRATED RANGEHOODS

Rear ducted to outside

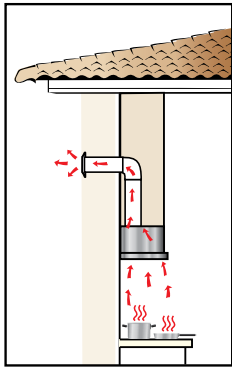

Top ducted to outside

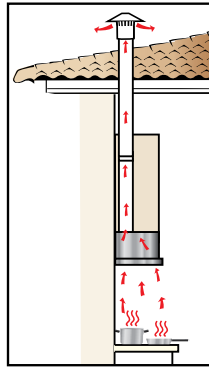

Side ducted to outside

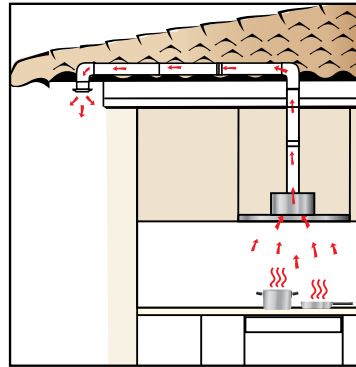

Side ducted through bulkhead

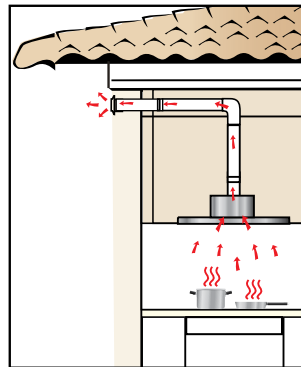

Top re-circulating through cupboard

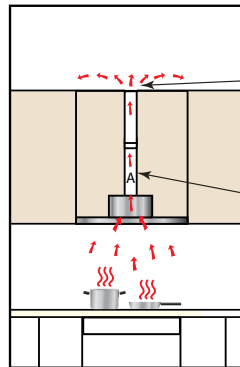

Top re-circulating through bulkhead

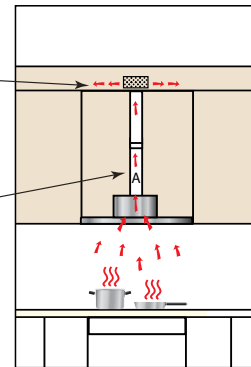

Mesh cover should be fitted over hole
(A) Ducting required

All IAG Appliances have a complete 2-Year Warranty on parts and labour. Our Toll Free Customer Service Number 1800 805 300 provides helpful advice and ready access to a nationwide service team.



EXTENDED WARRANTY

All IAG electric or gas appliances for your kitchen are now available with an OPTIONAL full 5 year Parts and Labour Warranty. Visit www.iagappliances.com.au or call our Toll Free Customer Service Number 1800 805 300 for details.